

# Data Sheet



Article number: 433000025

Description: Rota-fix shaft-hub connection C 25x30

Note: Not self centering. Small radial dimensions

## Measures

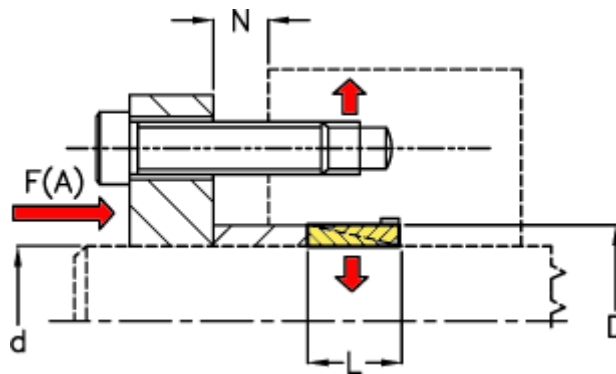

d mm = 25

D mm = 30

F(A) kN = 37

Fit tolerance = Aksel  $\varnothing$  ? 38 h6, Aksel  $\varnothing$  > 38 h8, Nav  $\varnothing$  ? 38 H7, Nav >  $\varnothing$  38 H8

F kN torque = 6.0

L = 6.3

N1 = 3

N2 = 4

N3

N4

P N/mm<sup>2</sup> surface press

Surface roughness

T N m torque